

IFP G101 / G102 SERIES COMBINATION PUMP/VALVE

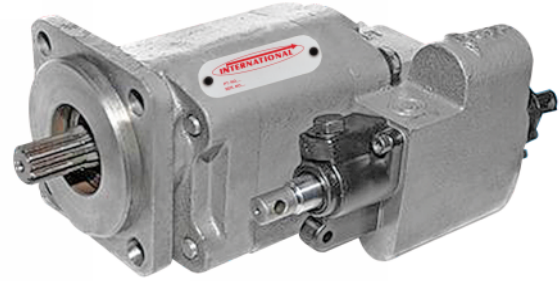

- * Rugged Cast Iron Construction
- * Interchangeable Parts
- "Parker / Commercial - Permco - Muncie"*
- * Optional Mountings / Actuators
- * High Performance / Low Cost



◆ Dump Pump/ Valve Ordering Code

IFP G102 - 2.0 - LH - M - 2

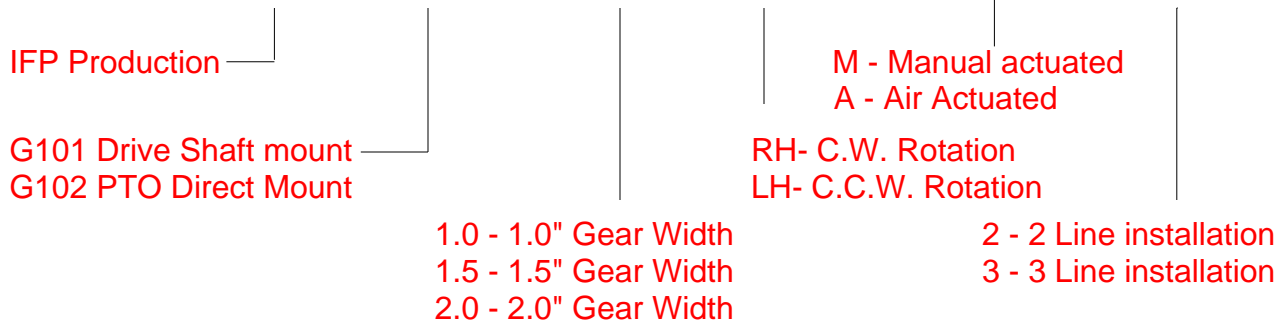

Model Number	Displ. (in ³ /rev)			Maximum PSI	US gpm @ 1800 rpm			Maximum Speed
	1.0	1.5	2.0		1.0	1.5	2.0	
G101	1.97	2.96	3.94	2500	9.5	21	29	2400 rpm
G102	1.97	2.96	3.94	2500	9.5	21	29	2400 rpm

IFP G101 / G102
Performance curves

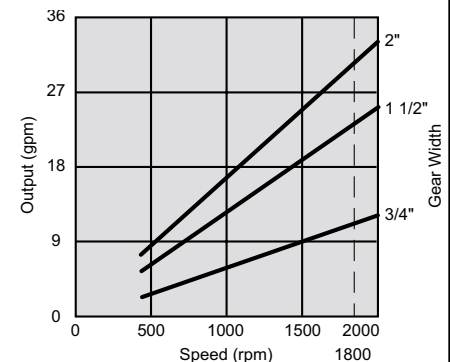

IFP offers G101 / G102 rugged cast iron combination gear pump / valve assemblies for the medium size dump and trailer applications. Units are available for SAE-B PTO mounting (G102) or remote drive shaft mounting (G101). Units are supplied with a full flow adjustable main relief valve to protect the pump and cylinder from over pressure and shock loads. A three position valve assembly controls the raising and lowering of a single acting cylinder, The pump / valve comes standard as manually operated & can be actuated by a cable control. The Pump/Valve can also be equipped with an air shift kit for actuation by air pressure. Installation can be either 2 line or 3 line configuration using the sleeve supplied .

IFP G101 / G102 SERIES

DIMENSIONS



IFP G101

Weight
 1.0" Gear Width = 31 lbs
 1.5" Gear Width = 35 lbs
 2.0" Gear Width = 38 lbs

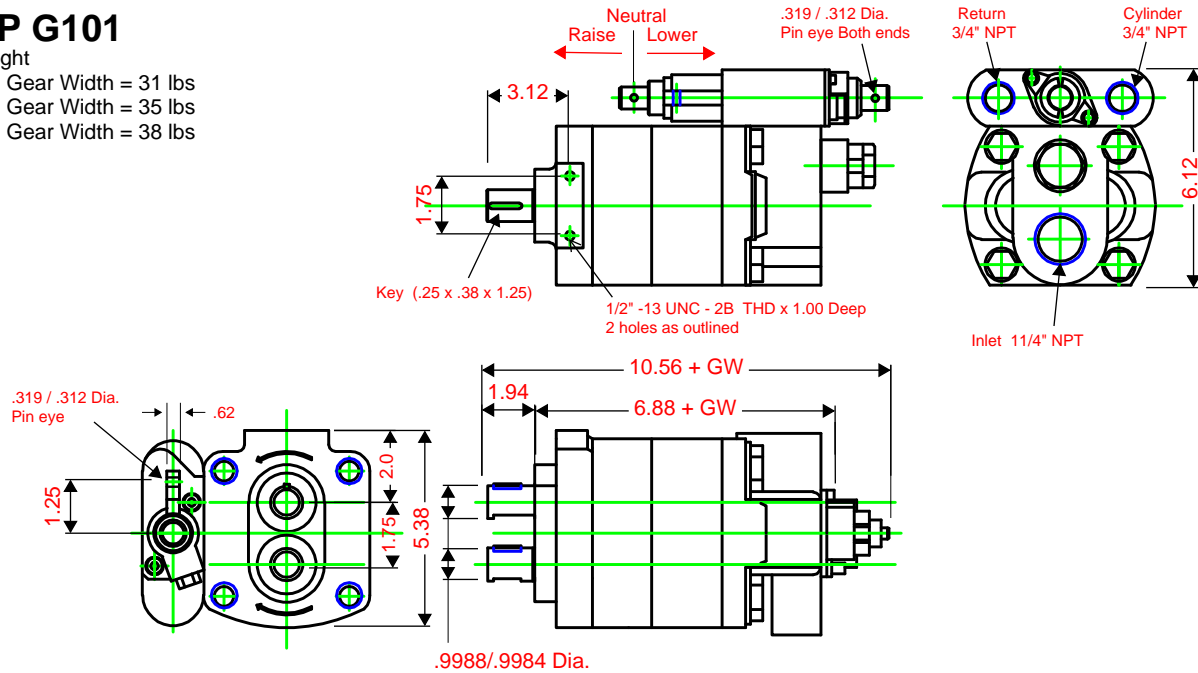

IFP G102

Weight
 1.0" Gear Width = 31 lbs
 1.5" Gear Width = 35 lbs
 2.0" Gear Width = 38 lbs

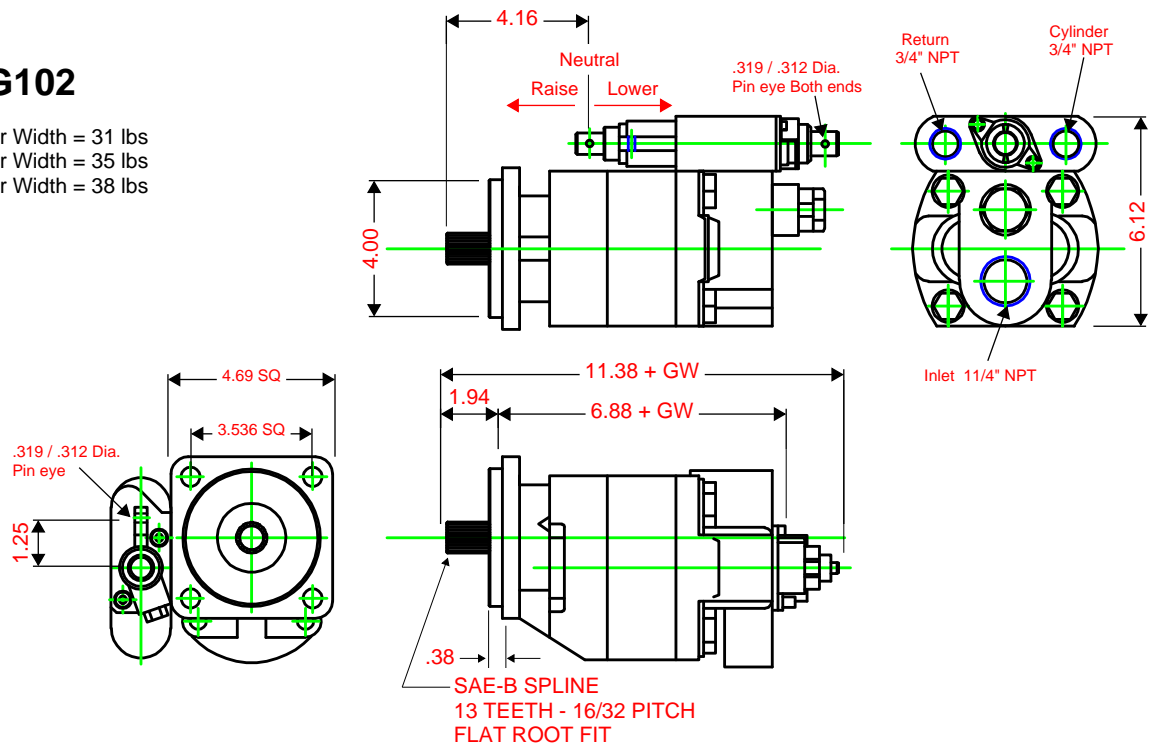

Dimensions - inch

IFP G101 / G102 SERIES INSTALLATION INSTRUCTIONS



2-line installation

One line to cylinder, one line to the reservoir. For intermittent operation only.

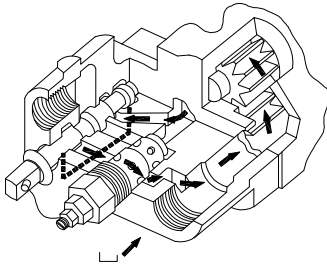

Spool in Neutral Position:

Oil recirculates internally.

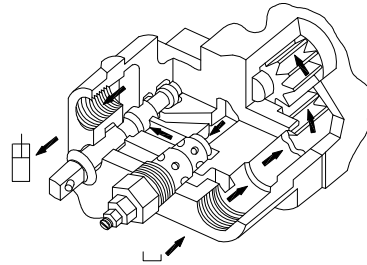

Spool in Raise Position:

Oil is routed through work port to raise the cylinder.

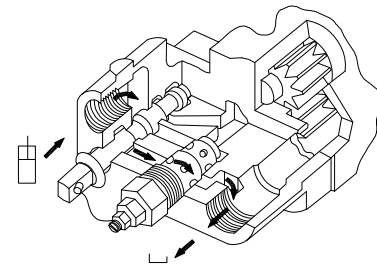

Spool in Lower Position:

Oil flows from the cylinder through the relief valve to return to tank.

3-line installation

One line to cylinder, two lines to the reservoir. For continuous or intermittent operation.

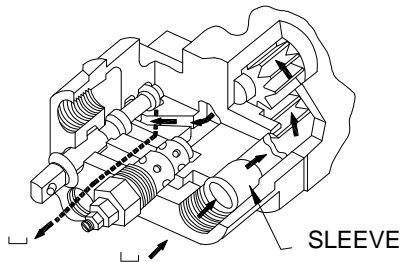

Spool in Neutral Position:

Oil circulates through the pump and returns to tank

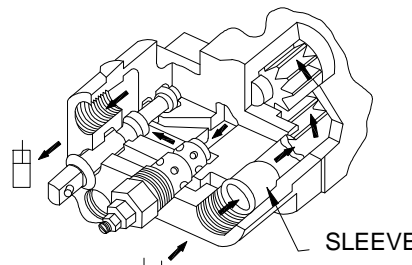

Spool in Raise Position:

Oil is routed through work port to raise the cylinder.

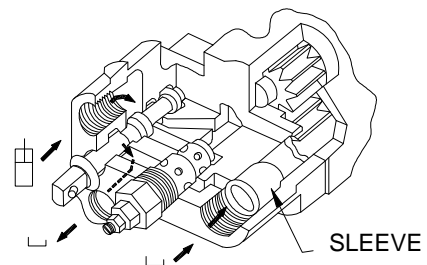

Spool in Lower Position:

Oil flows from the cylinder through the bottom port and returns to tank.

Note: Three line installation is recommended whenever possible by installing the sleeve supplied in the inlet port and connecting the optional return line to tank. This configuration maintains a lower operating temperature and a return line filter can be installed to filter return flow. Two line installations are for intermittent operation only.

IFP G101 / G102 SERIES PARTS BREAKDOWN

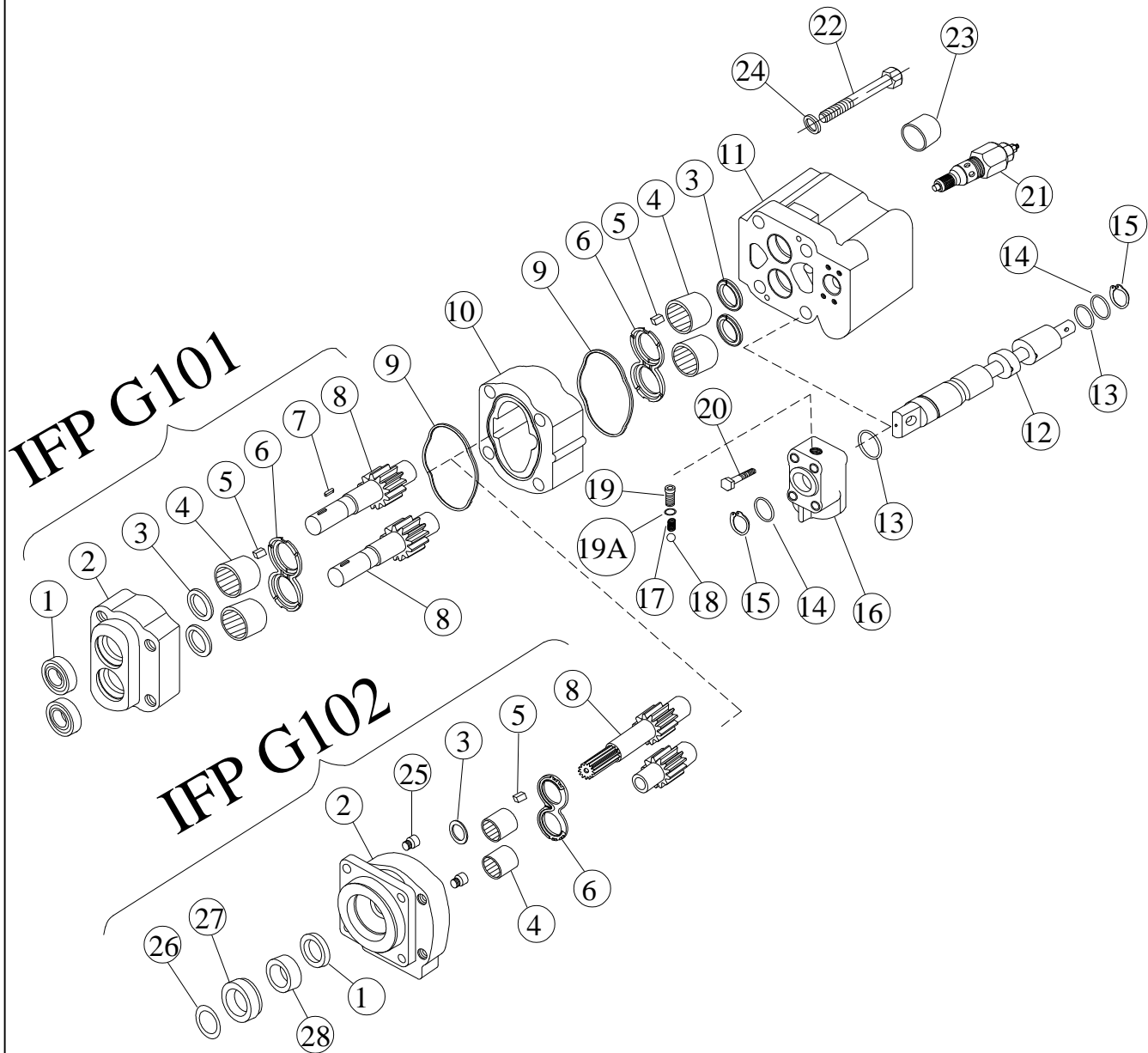

ITEM	DESCRIPTION	ITEM	DESCRIPTION	ITEM	DESCRIPTION
1	SHAFT SEAL	11	VAVLE HOUSING	20	CAP SCREWS
2	SHAFT END COVER	12	VALVE SPOOL	21	RELIEF VALVE ASSEMBLY
3	SHAFT RING SEALS	13	"O" RINGS	22	CAP CREWS
4	ROLLER BEARINGS	14	RETAINER RINGS	23	SLEEVE(OPTIONAL)
5	POCKET SEALS	15	SNAP RINGS	24	WASHERS
6	THRUST PLATES	16	VALVE CAP	25	CHECK ASSEMBLY
7	KEY	17	POPPET SPRING	26	SNAP RING
8	DRIVE HAFT&GEAR	18	STEEL BALL	27	SPACER
9	GASKET SEALS	19	DETENT RETAINER	28	RETAINER
10	GEAR HOUSING	19A	LOCAL WASHER		